

Carefully read this instructions booklet before installing or using this appliance.
Only by doing so will you have the best results and enjoy the greatest safety when using the appliance. Please pay particular attention to the warnings on page 28.

INTRODUCTION

This is a conditioner of the air-to-air type composed of two units: one internal (which operates inside the room) and the other external (to be installed outside). These two units are joined together by a sheathing (of about 4,5 m.) containing the refrigerant pipes, electrical power cables and condensation-discharge tube.

TECHNICAL FEATURES

Power supply	See the features plate
voltage	“
Maximum absorbed power	“
Cooling capacity*	“
Max. air flow rate	560 m ³ /h
Flexible tube length	4,5 m
Sheathing section	20 x 44 mm
Dimensions: indoor unit	
• length	560 mm
• height	735 mm
• depth	355 mm
• weight	44 kg
Dimensions: outdoor unit	
• length	570 mm
• height	480 mm
• depth	260 mm
• weight	18 kg
* Standard conditioning:	
Inside temperature	27°C
	relative humidity: 47%
Outside temperature	35°C
	relative humidity: 41%

OPERATIONAL AIR-CONDITIONING LIMITS

Room temperature	21 ÷ 32°C
Outside temperature	21 ÷ 43°C



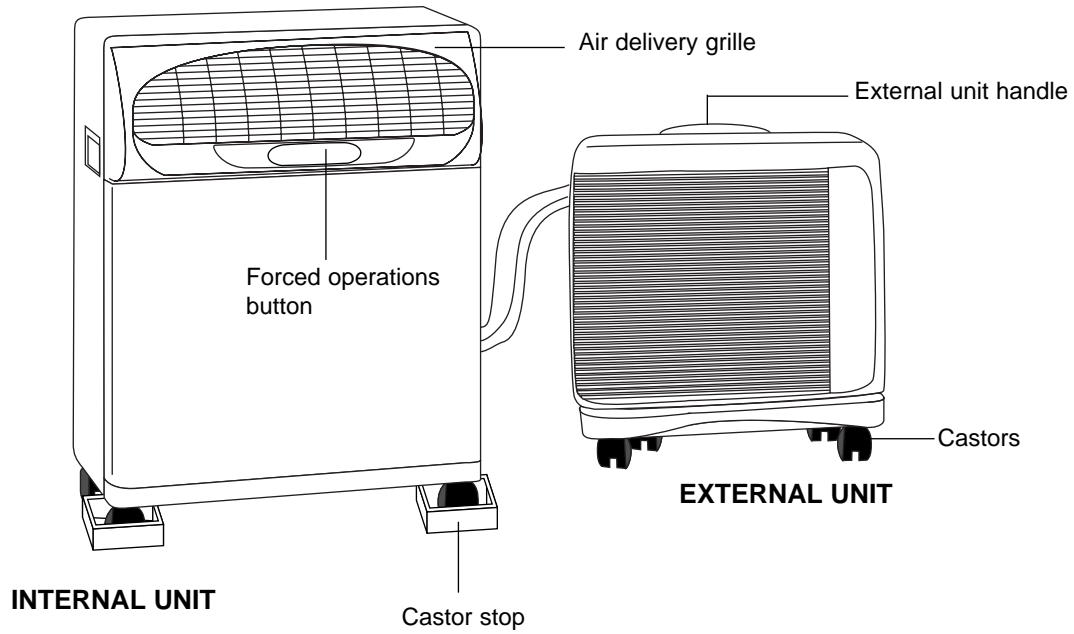



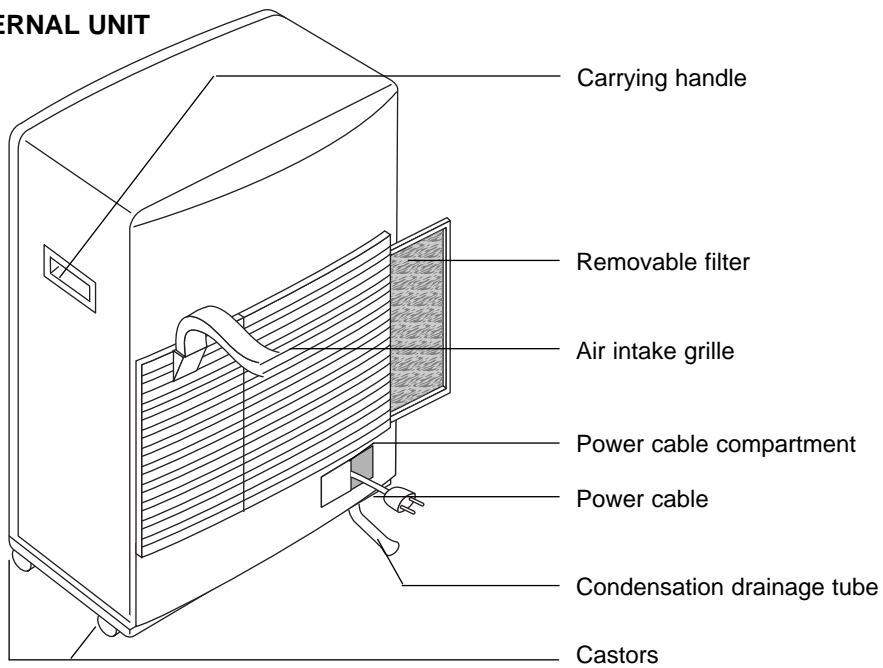



DESCRIPTION

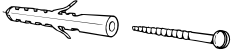

INTERNAL UNIT



ACCESSORIES

DRAWING	DESCRIPTION	NO. PIECES PROVIDED
	Wall-attachment bracket	2
	Support block for external unit	2
	Anchor screws + screws ø 6 mm	4
	Screws M6 mm	2
	Screws M4x25 mm	4
	Belt with hooks	2
	Screw eye for a belt	2
	Sheathing frame	1
	Castor stop	2
	Drain connection for condensation with seal and two 4.2 penetrating screws	1
	Castors for the external unit and washers	4

This appliance has been fitted with an **HE** (High Efficiency) system for low energy consumption, so after turning the appliance on you may have to wait a few minutes for cool air to begin circulating.

ELECTRICAL CONNECTION (U.K. ONLY)

- A) If your appliance comes fitted with a plug, it will incorporate a 13 Amp fuse. If it does not fit your socket, the plug should be cut off from the mains lead, and an appropriate plug fitted, as below.
WARNING: Very carefully dispose of the cut off plug after removing the fuse: do not insert in a 13 Amp socket elsewhere in the house as this could cause a shock hazard.
 With alternative plugs not incorporating a fuse, the circuit must be protected by a 15 Amp fuse.

WARNING - THIS APPLIANCE MUST BE EARTHED
IMPORTANT

The wires in the mains lead are coloured in accordance with the following code:

Green and yellow:
 Blue:
 Brown:

Earth
 Neutral
 Live



- If the plug is a moulded-on type, the fuse cover must be re-fitted when changing the fuse using a 13 Amp Asta approved fuse to BS 1362. In the event of losing the fuse cover, the plug must NOT be used until a replacement fuse cover can be obtained from your nearest electrical dealer. The colour of the correct replacement fuse cover is that as marked on the base of the plug.
- B) If your appliance is not fitted with a plug, please follow the instructions provided below:

As the colours of the wires in the mains lead may not correspond with the coloured markings identifying the terminals in your plug, proceed as follows:

The green and yellow wire must be connected to the terminal in the plug marked with the letter E or the earth symbol \equiv or coloured green or green and yellow.

The blue wire must be connected to the terminal marked with the letter N or coloured black.

The brown wire must be connected to the terminal marked with the letter L or coloured red.

INSTALLATION

The sheathing that connects the external to the internal unit may pass:

- a) through a slightly-open window or door;

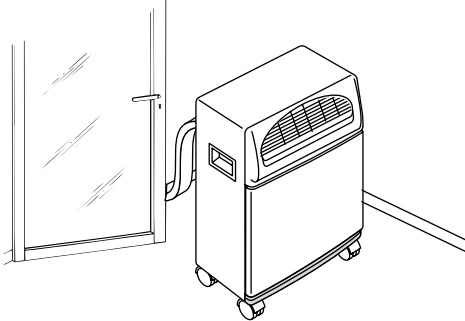

- b) through a small hole (5.5 cm x 2.5 cm) drilled in the lower part of a door or in a window frame by using the frame provided.

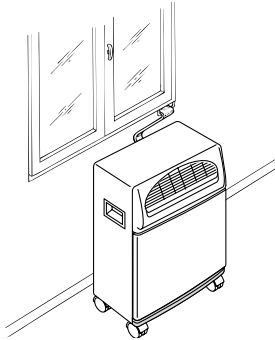

USE OF RAPID COUPLINGS

In addition to the methods described above, the sheathing that joins the external to the internal unit may also be drawn through a hole (about 6 cm. in diameter) drilled in a wall linked to the outside.

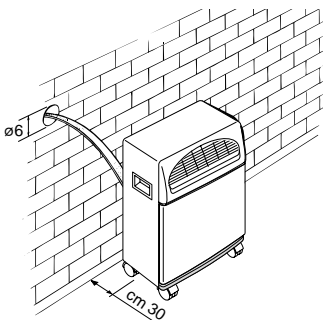

In this case, the hook-ups with the external unit must be disconnected as follows:

- 1) Remove the plug from the electric outlet;
- 2) Remove the handle by loosening the two screws and then slipping off the facing.

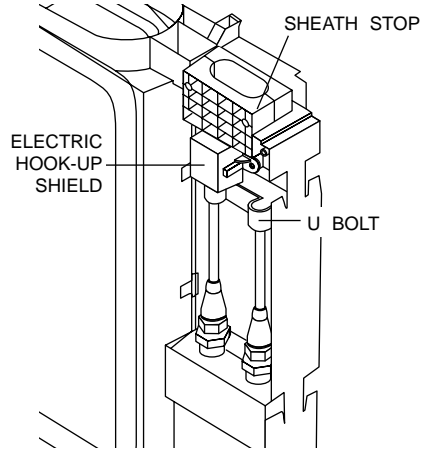

- 3) Remove the U bolt by loosening the two screws.
- 4) Remove the sheath stop by loosening the two screws.
- 5) Using a 24-version wrench, unscrew the union on the coupling. At the same time, hold the end of the flexible tube tight by using a 21-version wrench. Repeat this operation for the second union using a 24- and a 19-version wrench.

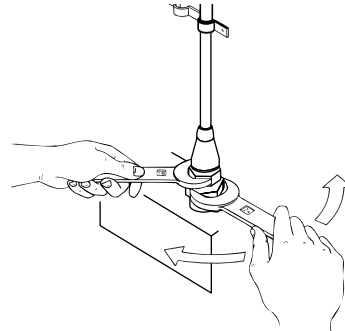

- 6) Disconnect the condensation tube from the rubber holder.
- 7) Loosen the shield's two self-threading screws and disconnect the electric hook-up unit.

The path of the connecting sheath should be as straight as possible, without sharp curves or kinks.

To re-connect the detached ends of the sheath to the internal unit, you must repeat operations 1 through 7 in reverse order, being careful to observe the following precautions:

- Before drawing the sheath through the hole in the wall, you should wrap the threaded ends of the speedy couplings with friction tape or the like as a protective measure.
- Fit the upper two cooling junctures into the two lower ones and hand-screw them several turns while checking to be certain they are well-fitted, and then tighten them with the wrenches used earlier.
- After having hooked up the two cooling junctures, tighten the U bolts.
- Check the grip on the cooling junctures by wetting the joints with a little soapy water. No bubbles should appear.

Caution:

We recommend that the disconnecting and connecting of the rapid couplings be carried out only by qualified technicians in the open air.

INTERNAL UNIT

Install the internal unit inside the room to be air-conditioned. This is usually done under a window or at least close to an outside wall.

The internal unit must be placed "on the level", with the help of the castor-stops provided. No obstacles should block this unit's in-take (suction grille) or out-take (outlet grille) areas.

EXTERNAL UNIT

The external unit may be placed on a terrace or balcony, in which case the brackets need not be used.

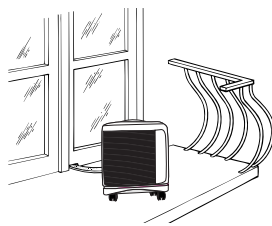

The external unit can be attached to a wall with the accessories included as follows:

- 1) Attach the bracket to the wall while taking care to place it as indicated in the drawing. Use the included template located on the plastic cover in order to drill the holes.

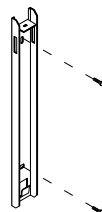

- 2) Screw the support blocks to the external unit with the included M4mm screws while taking care to place them so that the hole for the screws is on the upper side.
- 3) Attach the external unit to the bracket by means of the M6mm screws.

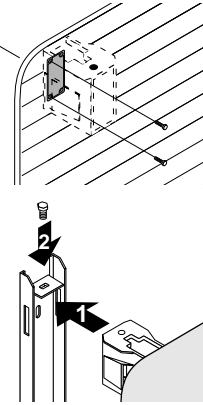

For temporary installation it is possible to hang the external unit as illustrated in the drawing. In this case, use the included straps by attaching them to the eye hooks. Before inserting the eye hooks remove the rubber plugs.

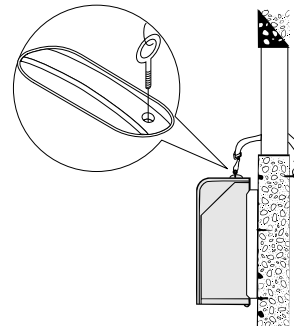

The external unit may be installed above or at the same height as the internal unit, on the condition that the difference is no more than 1.5 m.

The suction and air-delivery portions of external unit must not be blocked by obstacles of any nature.

The distance between the back of the appliance and the wall must be six (6) cm.

The condensation which forms while this appliance is running (summertime operations) is disposed of by evaporation from the external unit.

If the humidity is too high (in special cases), you must use the drainage coupling provided to get rid of condensation. This device must be mounted on the bottom of the external unit (see drawing) after the rubber plug has been removed.

We strongly recommend that you protect the external unit from rain, snow, direct sunlight and water dripping from the roof.

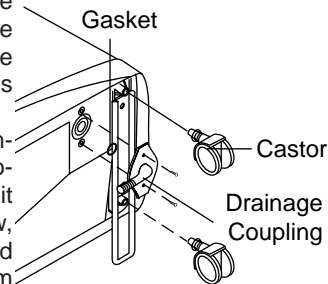

ELECTRICAL CONNECTION

Before plugging in check that:

- the mains supply corresponds to the value shown in the specifications table;
- the socket and the mains lead correspond to the power requirements of the appliance;
- the socket is suited to the plug , otherwise have the socket replaced;
- the socket is properly grounded. **The manufactures cannot be held responsible for any damages due to failure in following normal safety procedures.**

Replacement of the power cable must be carried out by qualified personnel.

- In order to insure low-cost operations, protect the room from direct sunlight by drawing the curtains and/or by partially lowering or closing the shutters or blinds

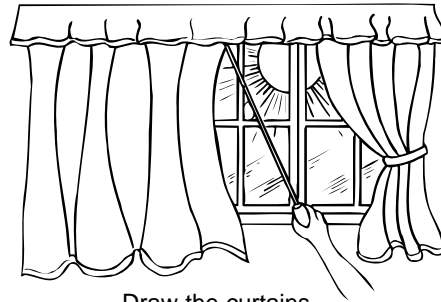

Draw the curtains

A LAST LOOK AT THE ROOM

There are several precautions you should keep in mind so as to get the best use out of your air-conditioner:

- Close the doors and windows in the room to be air-conditioned (except for temporary installation, in which case a window must be left partially open).



Lower (or partially close) the shutters

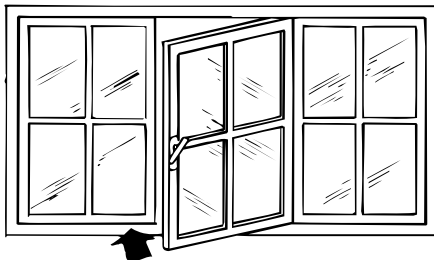

Close the windows

- Do not place objects atop the air-conditioner.
- Do not block the suction and air delivery areas.
- Make certain there are no heating sources in the room.

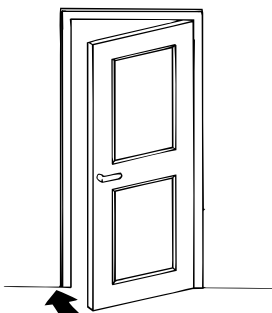

Close the doors

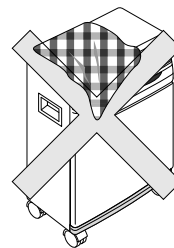

Do not cover

IN THIS WAY, YOUR AIR-CONDITIONER IS READY TO WORK, so now let's familiarise ourselves with its controls.

This appliance is equipped with a safety system which prevents the compressor from turning on until at least three (3) minutes have elapsed since the appliance was last turned off.

BUTTONS AND INDICATORS ON THE INTERNAL UNIT

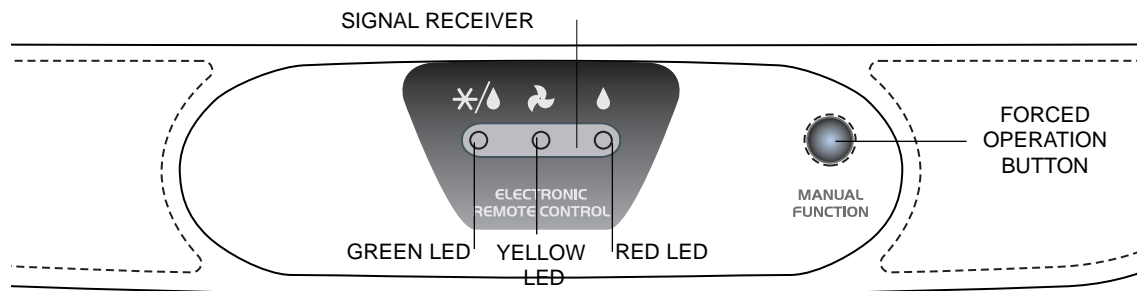

THE LEDS

Led displays come on depending on the selected function or as warning of possible anomalies.

FUNZIONE	GREEN LIGHT	YELLOW LIGHT	RED LIGHT
OFF	-	-	-
AIR-CONDITIONING	on	-	-
DEHUMIDIFYING	on	-	on
PURIFYING	-	on	-
SMART	As soon as this function is selected, all LED displays will remain on for some seconds until the control unit selects which mode to function in (whether air-conditioning, dehumidifier, fan or heater).		
TIMER	TIMER - if the TIMER mode is selected, the indicator lights remain on even when the appliance is off.		

ANOMALY	GREEN LIGHT	YELLOW LIGHT	RED LIGHT
ALARM	blinking	blinking	blinking

See "Troubleshooting" on page 29.

FORCED OPERATIONS

This is a way of operating to be selected if there are problems with the remote control (broken or lost, or the batteries run-down).

Press the Forced operation button until the required mode is selected (air conditioning, dehumidifying, fan, smart, off). Refer to the indicator lights and the table below to identify the mode selected. For each mode selected, the appliance will automatically choose the optimum values for maximum comfort.

REMOTE CONTROL

Inserting the batteries

- Slide the cover as shown in figure.
- Insert two new batteries (not rechargeable) making sure the (+) and (-) are in the correct positions.
- Put the cover back on, letting it slide into its original position.
- The Display will show all of the remote control's symbols for several seconds.

Note: WE SUGGEST USING ALKALINE BATTERIES (LR03).

If the remote control is to be replaced or thrown away, the batteries must be removed and disposed of in accordance with the current laws as it represents an environmental hazard.

When the remote control unit batteries are replaced, the air-conditioning indicator ☼ and heating indicator 🔥 will flash alternately on the remote control unit liquid crystal display. To set the remote control unit correctly, while ☼ is displayed, press any button.

If you do not press a button within 12 seconds, the remote control unit will also make the heating 🔥 mode available, despite the fact that this function is not available with this appliance.

PROPER USE



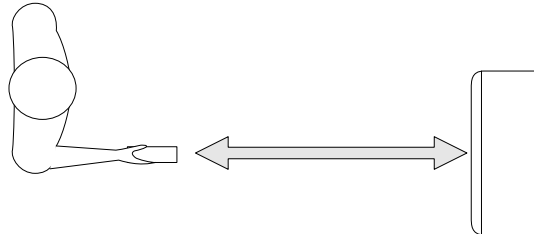
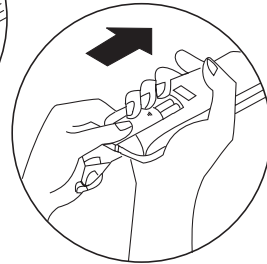
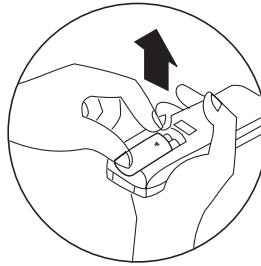
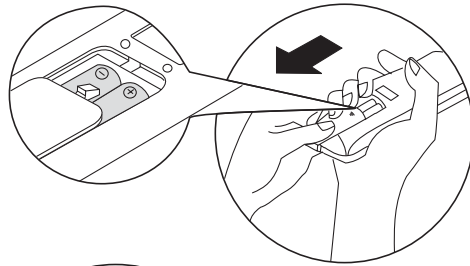



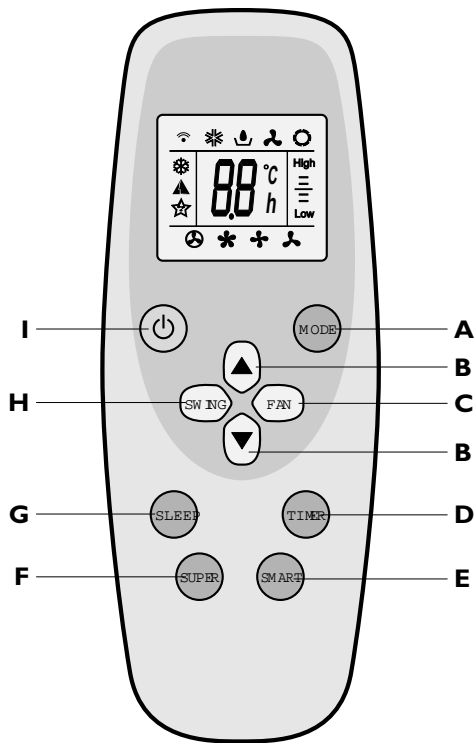





- Point the remote control unit towards the air-conditioning unit signal receiver.
- Maximum distance: about seven (7) metres (without any obstacle between remote control and receiver).
- The remote control must be handled with **great care**: do not drop it, expose it to direct sunlight, or leave it close to heat sources.



THE REMOTE CONTROL



IL DISPLAY

-  Signal transmission
-  Air conditioning indicator
-  Dehumidifying indicator
-  Fan indicator
-  Heating indicator (mode not available with this appliance)
-  SUPER air conditioning indicator
-  SMART indicator
-  SLEEP indicator
-  Automatic fan speed
-  High fan speed
-  Medium fan speed
-  Low fan speed

High

 Regulates temperature in SMART or

 Dehumidifying level.

Low

A. MODE button

Selects the operating mode (air conditioning, dehumidifying, fan).

B. ROOM TEMPERATURE buttons

Set room temperature or programme the timer.

C. FAN button ()

Sets fan speed to automatic, high, medium or low in sequence.

D. TIMER button

Sets or cancels the timer.

E. SMART button ()

When this button is pressed, the appliance automatically establishes the most suitable operating mode for maximum comfort.

F. SUPER button ()

Starts or stops rapid cooling (in the rapid cooling mode, the fan operates at high speed with the temperature automatically set at 18°C).

G. SLEEP button ()

Sets or cancels the automatic SLEEP function.





H. SWING button (wall mounted models only)

Starts or stops swing of the air distribution vertical adjustment fins and sets the required air flow direction upwards or downwards.

I. ON/OFF button

Press this button to turn the appliance on and off. NB: the settings are displayed even when the air conditioner is off.







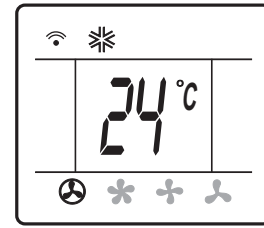

AIR-CONDITIONING MODE

- Press the  button to turn the appliance on.
- A beep indicates that the air-conditioning unit is on and the  symbol flashes on the display
- Press the MODE button a number of times until the air-conditioning symbol  appears on the display.
- Now set the temperature using the   buttons.
- To select fan speed, press the FAN button repeatedly until the required fan speed is selected (automatic, high, medium, low).

NB: in air-conditioning mode, the appliance automatically removes excess moisture from the atmosphere.



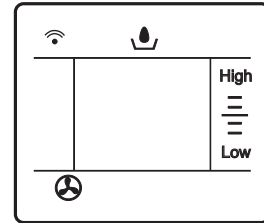

DEHUMIDIFYING MODE

- Activate this function when humidity is high.
- Press the  button to turn the appliance on. A beep indicates that the air-conditioning unit is on and the  symbol flashes on the display.
- Press the MODE button a number of times until the dehumidifying symbol  appears on the display.
- Use the buttons to set the required level of dehumidifying. The   symbol is displayed 
 - Press the  button to increase the dehumidifying level and the  button to reduce it.
 - In dehumidifying mode, fan speed is selected by the appliance automatically.



FAN MODE



On humid but not particularly hot days, the fan function alone may be adequate.

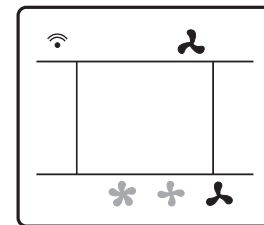

- Press the  button. A beep indicates that the air-conditioning unit is on and the  symbol flashes on the display.
- Press the MODE button a number of times until the fan symbol  appears on the display.
- Once fan mode has been selected, press the FAN button until the required speed is reached (low, medium, high).



SMART MODE

In SMART mode, the air-conditioning unit decides the best way to operate to guarantee maximum comfort.





- Press the  button to turn the appliance on. A beep indicates that the air-conditioning unit is on and the  symbol flashes on the display.
- Press the SMART button. The appliance functions automatically and the  symbol appears on the display.

NB: in SMART mode, temperature is controlled automatically. However, if the required temperature has not yet been reached, it can be reduced or increased by a maximum of 2° C by pressing the   buttons.

It should be pointed out that when the automatic ventilation functions are activated, the appliance itself will choose the proper speed.

AUTOMATIC SLEEP MODE

The automatic SLEEP mode is ideal for the night-time as it enables operation of the air-conditioning unit in any of the modes (air-conditioning, dehumidifying, fan or SMART) to be gradually reduced until it shuts down completely (after eight hours). To select SLEEP mode, proceed as follows:

- Press the  button to turn the appliance on.
- A beep indicates that the air-conditioning unit is on and the symbol  flashes on the display.
- Press the MODE button a number of times until the symbol of the function required appears on the display.
- Then select the required temperature by pressing the   buttons.
- Now press the SLEEP button to set the night function. The symbol  is displayed. Press the SLEEP button again to go back to the previous mode. In this mode, the fan operates at low speed.

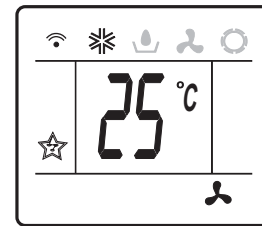
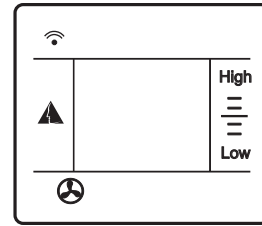

N.B: The night-time function makes it possible to keep a room at a perfect temperature, thus preventing an excessive rise or a drop in temperature while the silent operation is in effect. The air-flow will decrease, while the room temperature will vary gradually to provide the ideal condition: the temperature will increase by 1° C. after 60 minutes and by 2° C. after two hour (it goes off altogether after 8 hours).



SUPER MODE

SUPER mode is used to turn rapid cooling on or off. The fan is set to high speed and the temperature is automatically set to 18° C.

To select SUPER mode, proceed as follows:

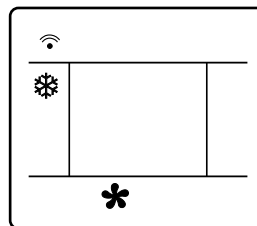

- Press the  button to turn the appliance on. A beep indicates that the air-conditioning unit is on and the  symbol flashes on the display.
- Press the SUPER button to set the mode. The  symbol is displayed.
- To go back to the previous mode, press the SUPER button again.



PROGRAMMING THE TIMER



After selecting the required operating mode, activate the timer by pressing the TIMER button when you go out in the morning to obtain a comfortable room temperature at the time you will be coming home.

Programming the turn-off function

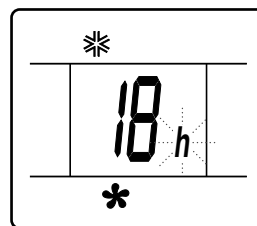
- With the air-conditioning unit on, press the TIMER button. The time is displayed and the "h" symbol flashes. Set the time when you want the appliance to go off using the   buttons (from 30 minutes to 24 hours).
- Press the TIMER button again to confirm the selection. A countdown of the time left is displayed.
- At the end of the set time the appliance goes off automatically. During the first ten hours, you can select half hour intervals. For times greater than ten hours, one hour intervals can be selected.
- To cancel the set time, press the TIMER button again. You will hear a beep.



Programming the ON function

- With the air-conditioning unit off, press the TIMER button. The time is displayed and the "h" symbol flashes. Set the time when you want the appliance to come on using the   buttons (from 30 minutes to 24 hours).
- Press the TIMER button again to confirm the selection. The three indicator lights on the air-conditioning unit come on.
- At the end of the set time the appliance comes on automatically. During the first ten hours, you can select half hour intervals. For times greater than ten hours, one hour intervals can be selected.
- To cancel the set time, press the TIMER button again. You will hear a beep and the three indicator lights on the air-conditioning unit will go off.

MAINTENANCE

Always pull the plug from the electrical outlet before beginning any cleaning or maintenance operations.

For safety reasons, never wash the air-conditioner with water.

CLEANING THE UNIT

Clean your air-conditioner with a damp cloth and then wipe it with a dry cloth.

Precautions:

Never use gasoline, alcohol or solvents to clean this appliance. Never spray it with insecticide or similar liquids, because the paint might then peel away and the plastic portions might lose their true shape.

CLEANING THE AIR FILTER

- If the air filter gets dirty, it will be difficult for the air to circulate and the air-conditioner will lose much of its efficiency, thus leading to about an 8% increase in electrical consumption. For this reason, it is a good idea to clean the filter
- Remove the air filter as shown below.

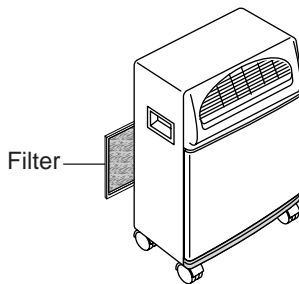

- Use a vacuum cleaner to remove the dust on the filter. If the filter is very dirty, dip it in warm water (of less than 40° C.) and rinse it several times. After having washed the filter, let it dry completely before putting it back in place.

CHECKS TO MAKE AT A SEASON'S BEGINNING

Check to make certain that the power cable and the electrical outlet are in perfect condition and that there is a suitable earthing system.

Give strict observance to all installation norms.

WORK TO BE DONE AT A SEASON'S END

Turn off the air-conditioner.

Clean the filter and dry it before putting it back in place.

Cover the air-conditioner with a plastic bag to keep the appliance from getting dusty.

Remove the batteries from the remote control device.

IMPORTANT SAFEGUARDS

- This appliance has been built to air-condition, dehumidify and ventilate rooms in the home and must not be used for other purposes.
- Changing or altering the features of this feature in any way is dangerous.
- If repairs are needed, always contact only a Technical Assistance Centre authorised by the manufacturer. Repairs by unauthorised personnel may be inherently dangerous.
- This appliance must be connected to an efficient "earthing" system. Have your electrical system checked out by a qualified electrician.
- Avoid using extension cords for the electric feed cable.
- Before any cleaning or maintenance, always pull the plug from its electric outlet.
- Never pull on the feed cable to move this equipment.
- Do not install this appliance in rooms where the air may contain gas, oil or sulphur or in the close proximity of a heat source.
- Never place heavy or hot objects on this air-conditioner.
- Clean the air filter at least once a week.
- When being moved, this appliance must be kept in an upright position or placed carefully on one side.
- Do not make use of heating equipment in the close proximity of this air-conditioner. After having moved this appliance, wait for at least one (1) hour before turning it on again.
- If the power cable is damaged, it must be replaced by a qualified professional authorised by the manufacturer only.
- At the end of its working life, take the appliance to a special collection centre.
- When putting the appliance away, do not cover with plastic bags.
- The refrigerant gas R290 conforms to EC regulations on the environment. Avoid perforating the refrigerant circuit of the appliance.
- If the appliance is used in rooms without adequate ventilation, take the necessary precautions to avoid possible leaks of refrigerant gas stagnating in the atmosphere, creating a fire risk.
- This appliance must be used and kept in rooms with a volume of more than 31m³.
- If an appliance containing flammable refrigerant is used in an unventilated room, make sure the room is suitable and that there is no danger of gas leaks reaching a concentration which could cause fire or explosion in the presence of other heat sources (electrical heating appliances, heaters or similar).

IF SOMETHING GOES WRONG

Most malfunctions are caused by a very minor and easily solved problem. So carefully check this list before contacting the Authorised Technical Service Centre in your area.

PROBLEMS	CAUSES	REMEDIES
The air-conditioning is not working	<ul style="list-style-type: none"> • Lack of electrical power • The plug has not been inserted • The timer has been set improperly 	<ul style="list-style-type: none"> • Wait • Insert the plug in the electrical outlet • Set the timer correctly
The cooling is insufficient	<ul style="list-style-type: none"> • Dirty air filter • Room too warm • Temperature set incorrectly • The air in-take & out-take grilles are blocked 	<ul style="list-style-type: none"> • Clean the air filter • Wait for the cooling to begin • Set the temperature correctly • Clean the grilles
Strange odour in the room	<ul style="list-style-type: none"> • Dirty air filter 	<ul style="list-style-type: none"> • Clean the air filter
Build-up of condensation from the air-conditioner's internal unit	<ul style="list-style-type: none"> • Internal unit water tray full • Appliance not installed correctly 	<ul style="list-style-type: none"> • Drain the water through the condensation tube located on the back of the unit • See p. 19 for information on proper installing
Remote control signals are weak or inexistent	<ul style="list-style-type: none"> • Batteries run down • Batteries may be inserted incorrectly 	<ul style="list-style-type: none"> • Change the batteries • Check the batteries' (+) and (-) poles
The air-conditioner does not start working until 3 min. after it has been turned on	<ul style="list-style-type: none"> • The safety device will click on 	<ul style="list-style-type: none"> • Wait for 3 minutes to pass
The compressor turns on and off intermittently	<ul style="list-style-type: none"> • The air-conditioner is operating as a dehumidifier • The anti-icing safety device switches on 	
The 3 LED indicators are flashing	<ul style="list-style-type: none"> • internal water pan full 	<ul style="list-style-type: none"> • unplug, empty the pan by draining the water through the condensate drain tube at the back of the appliance. • plug in again • if the indicator lights continued to flash, contact a Service Centre.

SERVICE

If the problem persists after these checks have been made, contact your nearest authorised Technical Service Centre. Specify the model you own and the type of defect encountered.

Transport, filling, cleaning, recovery and disposal of refrigerant should be performed by a technical service centre appointed by the manufacturer only.

The appliance should be disposed of by a specialist centre appointed by the manufacturer only.